



Welcome to Fiber Optics

Product Guide

Gel Free Corning Cables

- ALTOS All-Dielectric Loose Tube Cables manufactured by Corning Cable Systems are lightweight cables used for *outdoor* aerial and duct (lashed) installations. The loose tube design is compatible with any telecommunications optical grade fiber and provides stable performance over a wide temperature range
- Corning Cable Systems FREEDM® LST™ Gel-Free Cable is perfect for inter and intra building backbones for aerial, duct and riser applications. FREEDM LST Cables are installer friendly. Cable preparation is a snap because these cables contain no messy gels, and the buffer tubes and fibers in each tube are color-coded for quick, easy identification.

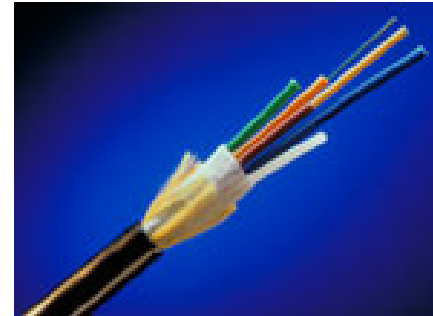

Corning Altos All-Dielectric Cables



FREEDM LST Gel-Free Cable

Specialty Plenum Cables



- Corning cable systems FREEDM® One Plenum and Riser Cable is designed to the new ICEA-696 standard, and ensures reliable outside and inside plant cable performance, perfect for use in short distance campus backbone applications. They are NEC OFNP/FT-6 listed for Plenum and OFNR/FT-4 for Riser, RoHS compliant, UV-resistant and fully water blocked for indoor/outdoor applications.
- Corning Cable Systems OFNP MIC® Plenum Cables are perfect for routing cable inside buildings, building backbone, horizontal installations in plenum areas, riser shafts, telecommunications rooms and work stations for all high speed data applications.

Riser Cables



- Corning Cable Systems OFNP MIC® Cables are perfect for routing cable inside buildings, building backbone, horizontal installations in riser shafts, telecommunications rooms and work stations for all high speed data applications.



- With fiber counts ranging from 12 to 216, Corning Cable Systems Ribbon Riser Cables are made up of easy to identify 12-fiber ribbons, which are all held together within a central tube

Singlemode / Multimode Patch Cables

- **Singlemode** is an optical fiber, with a small core (2-9 microns that supports one mode). The mode Size (standard ie 8.3/125) is stamped on the yellow cable jacket. **Singlemode** is most commonly used for high speed, long distance applications.
- **Multimode** is an optical fiber with a core (25-200 microns) that supports several modes. The core commonly 62.5/125 or 50/125 is stamped on the cable jacket. **Multimode** is most commonly used for lower speed, short distance applications.





Fiber Optic Enclosures

Single Panel Housing (SPH)

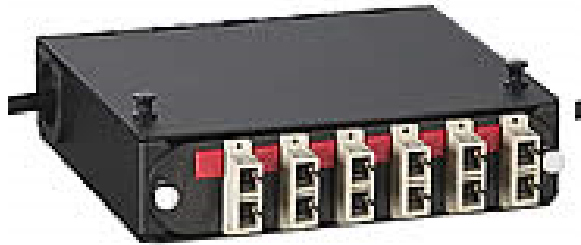

CORNING

- The Single Panel Housing is a cost-effective product manufactured by CORNING, ideally designed to store, protect and terminate optical fiber cables and connectors in the physical plant.

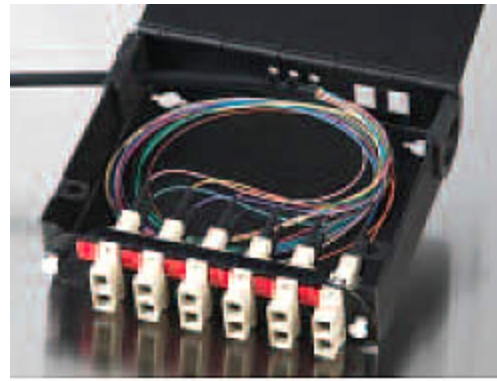
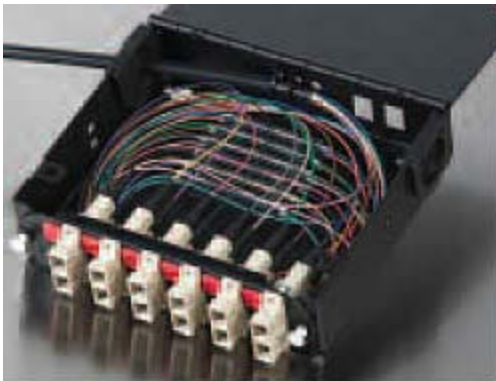

Wall-Mountable Connector Housings (WCH)



CORNING

- Corning Wall-Mountable Connector Housings (WCH) optimized design provides your network with interconnections or cross-connections capabilities between optoelectronics and outside-plant, riser and distribution cables.
- Their durable clear, tinted doors allow for easy viewing of jumper connections. These units are available in two, four, six and twelve-panel configurations, and can be wall-mounted in telecommunications rooms and main cross connects.

Wall Mount Fiber Patch Panel Enclosures



- Pre-loaded patch panels
- Can be used for 19" or 23" racks
- Bend radius controllers are mounted so as to maintain optimal bend radius for cable slack whether patching or splicing

Rack Mount Fiber Patch Panel Enclosure



- Pre-loaded fiber patch panels
- Can be used for 19" or 23" racks
- Bend radius controllers are mounted so as to maintain optimal bend radius for cable slack whether patching or splicing

Black Box Fiber Optic Wall Mount Cabinet



- These cabinets feature full front access to pigtails and connectors as well as a splice tray mounting stud. They also come with all the hardware you need to route fibers and secure the cables. A splice tray mounting stud is also available.

Black Box Rackmount Fiber Optic Cabinets



- Allows you to organize and protect your fiber connections with its lockable front covers
- Smoked plastic front cover that enables you to view cable terminations when it is closed, while at the same time protect your patch cords from dust and dirt
- All models come with adjustable rackmount brackets for mounting in cabinets

Opt-X® 1000 Rack-Mount Enclosures



- Enclosures are available with or without adapters in them.
- Three single-piece bulkhead options to choose from: SC, ST, or an empty bulkhead for any three OPT-X Adapter plates (sold separately)
- Completely top removable with tilt-up, removable front door to provide unobstructed access to the enclosure interior
- Dual Fiber Management Rings are adjustable and removable, to help accommodate large quantities of slack storage at the rear of the tray
- UL Rated 94V-0 self-extinguishing plastic

Leviton DPS Optical Splice Enclosures



- Compatible with Leviton standard splice trays
- Ideal for 19" or 23" rack mount environments
- Manufactured from high strength aluminum for durability
- Easy installation and maintenance access with removable hinged front and rear doors
- Cable management rings are large for easy routing of jumpers
- DPS optical splice enclosures meet and comply with NEBS GR-63 requirements

Hoffman FTTX Fiber Optic Cabinets



- Manufactured from 0.125" thick aluminum
- Seams continuously welded and ground smooth
- Heavy gauge continuous hinge
- Finish is outdoor-grade polyester powder paint
- NEMA/EEMAC Type 3, 3R, 4, 4X, 12

Wall-Mountable Slack Storage Housing (WCH-SSH)

CORNING

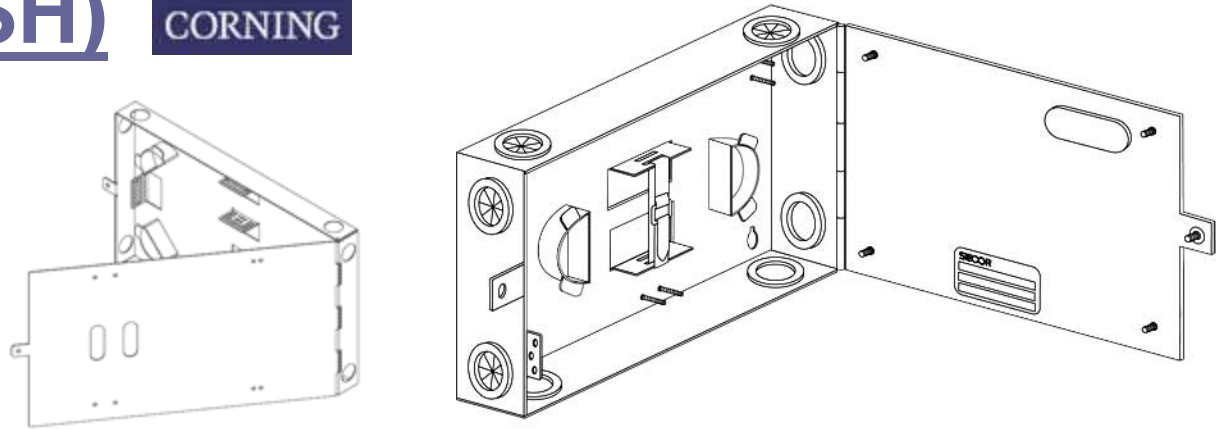

- Compact size, low profile
- Accommodates a wall-mountable connector housing
- Multiple cable entry holes (top and sides)
- Includes provisions for strain-relieving optical fiber cables
- Unit can be rotated on the wall when mounting so the door swings to either the left or right.

Black Box Fiber Optic Adapter Panels



 **BLACK BOX**
NETWORK SERVICES

- These panels are meant to be used for patching fiber cable to the termination enclosure of your choice: fiber wall cabinets, rackmount fiber cabinets or rackmount fiber shelf. They snap in easily into the enclosures and enable you to make quick and easy fiber patch panel connections.

Leviton Opt-X® Adapter Plates

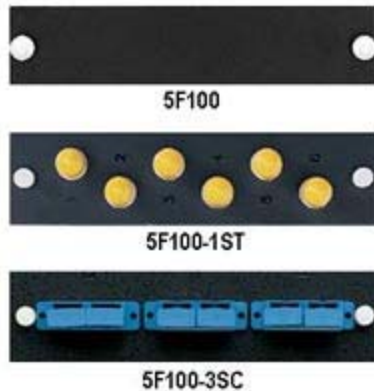

- Meets all applicable compliance standards TIA/EIA –568-B
- Allows the installer the ability to add or change connector styles
- Adapter plates feature multiple-style adapters
- Plastic plungers allow for fast, easy, tool-free installation
- Provides 6, 8 or 12 ports for ST, FC, LC, MT-RJ and QuickPort Adapters

Black Box High Density Fiber Adapter Panels

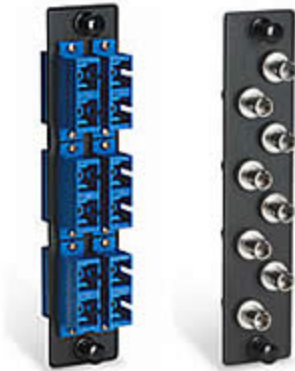

- Snap easily into our open lock , Rackmount Fiber Shelf, and [Rackmount Fiber Cabinets](#), and enable you to make your fiber patch panel connections
- Panels feature high-retention phosphor bronze alignment sleeves that work with both multimode fiber and non-angle polish single-mode fiber
- Easy way to [patch fiber cables](#) to termination enclosures

Black Box LC High Density Fiber Panel Adapter

- The Black Box LC HD Fiber Panel Adapter is an easy to snap adapter panel that enables you to add more connections, fiber workgroups, or organize interconnections for a fiber network.





Media Converters

Signamax 10/100BaseT to 100BaseFX Media Converter with Link Fault Signaling



SIGNAMAX™
CONNECTIVITY SYSTEMS

- Signamax is our most spec'd in media converter providing one channel for media conversion.
- It translates transmission signals from a twisted-pair 10BaseT or 100BaseTX cable to 100BaseFX fiber optic cable.
- Can be used as a stand alone device or placed in a 19" chassis (sold separately).
- Built in twisted-pair port 10/100 switch.
- Auto-Negotiation RJ-45 Connector with Auto-MDIX.
- SC, ST, MT-RJ or SC Connector options.
- Lifetime performance guarantee.

Gigabit Media Converter



- Complies with IEEE 802.3ab 1000Base-T
- Complies with IEEE 802.3z 1000Base-SX/LX Standard
- SC type connector
- Four DIP switches

Signamax 10/100BaseT/TX to 100BaseFX DIN Rail Mount Industrial Hardened Media Converter



- This device will change signals on a copper cable to signals that run on fiber, allowing you to introduce fiber technology without making other changes
- An economical solution for your outdoor ethernet needs where temperature and humidity play a role in the integrity of your signal
- Front panel status LED's allows you to see what's happening without having to get into tight spots

10/100 to 100FX WDM DIN-Rail Mount

Hardened Media Converters



- Convert data from twisted pair cable to fiber optic for excellent results
- Developed to function in harsh commercial environments that require ruggedized equipment that can operate in severe temperature extremes
- An affordable solution for outdoor environments, transportation roadside systems, shop floors, and other harsh environments
- Able to withstand extreme temperatures for any harsh conditions your installation may face

Signamax 16-Bay Rack Mount Media Converter Chassis



- High port density in a minimum amount of rack space (2U).
- Accommodates 16 Signamax SX-065-11XX media converters.
- Dual redundant load sharing power suppliers so the converters remain in service at all times.
- Four redundant fans for system cooling.

Black Box Async Mini Fiber Optic Modem



- High-performance drivers enable you to send RS-232 data across interference-free optical links
- Sends RS-232 data, at up to 76.8 kbps, from serial devices to a server over multimode fiber cable
- Supports RS-485, RS-422, V.11, V.52, AND V.54, so you get great versatility in use and reduced errors in communications
- Operates full duplex over 4-wire, and half duplex over 2-wire or 4-wire so you are assured this mini fiber optic modem will work with all your equipment

Black Box Campus Fiber Driver



- Allows you to recover jitter free data and clock with Phase Locked Loop PLL circuit
- Enables communication between two V.35 or X.21 data devices over a fiber optics
- Operates with many grades and sizes of fiber optical cable for your convenience



Fiber Optic Connectors

Black Box Fiber Optic Connectors

More Than a Few Ways to Connect Multimode & Single-Mode Cabling

- Three types of connectors to terminate your fiber optic cables are available to suit any application
- The UV-Curable, Reduced-Piece-Part, Glass-Insert Multimode Connectors (BB-FO110 and BB-FO111) only have three pieces to assemble: boot, strain relief, and connector body
- UV-Curable adhesive comes in a syringe and cures in one minute or less



Fast-Cure Adhesive-Style Connectors

LEVITON



- TIA/EIA-604 and 568-B compliant
- -40° C to +85° C operating temperature
- Compatible with Leviton adapters
- Precision mode pre-radiused zirconia ferrules
- High cable retention crimp ideal for jacketed fiber
- Connectors come with a 900µm and 3.0mm boot

Thread-Lock® Fiber Optic Connectors - Leviton

- TIA/EIA 568-B compliant & meets FCC Part 68.
- Insertion loss typical at 0.20dB.
- Available in both single mode and multimode.
- Reusable.
- No epoxy or special crimp tools required to terminate single mode or multimode fiber.



LEVITON

UniCam® Multimode Connectors

Easiest field terminator on the market!



- Easy and fast installation, only 2 minutes per fiber!
- The perfect solution for all installable multi-mode and single-mode fiber optic connector requirements.
- Field fiber and fiber stub get fully protected from environmental factors.
- No polishing, no epoxy, no power cords, or polishing films required.
- Compliant with ANSI/TIA/EIC-568-13.3.

CORNING

Black Box Fiber Optic Adapters

Use These Adapters to Link Your Fiber Optic Cables

- Allows you to link various different types of fiber optic cable
- Bronze sleeves provide durability for multimode applications
- Features a panel mount design for easy installation in modular patch panels

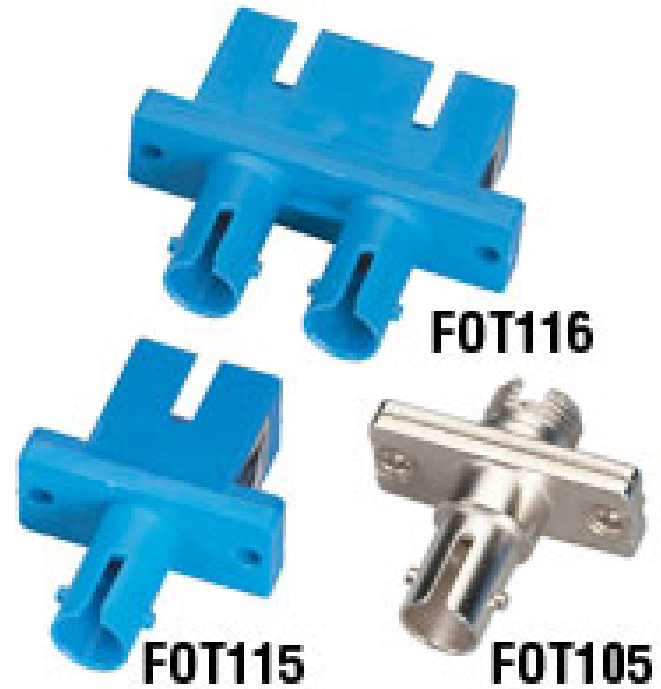

Black Box Fiber Optic Couplings



- Ideal quick solution when you need to couple two fiber optic cables or match fiber optic connectors
- All couplings feature a panel-mount design for easy mounting
- Choose from single-mode or multimode styles, as well as from multiple connector types



Corning UniCam® Pretium™ Performance Multimode Connectors LC, SC, ST Compatible

- Best in class optical performance.
- 100% guaranteed .1 typical dB/.5 dB maximum insertion loss per connector pair.
- Use with the Unicam Pretium Tool Kit for fastest most precise installation.
- Available in single packs or 25 packs.

CORNING



Corning UniCam® Pretium™ Performance Single Mode Connectors LC, SC, ST Compatible

- Superior optical performance with 45 second install time.
- 100% Guaranteed .2 typical dB/.5 dB maximum insertion loss per connector pair when using Unicam Pretium Tool Kit.
- Fast easy installation lowers labor costs.
- No consumables needed.
- Ideal for fiber deployments in local area networks (LAN), data centers, and campuses.

CORNING



Black Box Fiber Optic Loopback Connectors

The Right Equipment for Loopback Testing



- Various SC, MT-RJ, MTP, and LC connectors and adapters to provide you with the right tools for loopback testing
- The SC connector is ideal to use for equipment testing in multimode and single mode applications, as well as network applications

Black Box Fiber Optic Adapter Kit

Quickly Make Fiber Connections With This Handy Kit



- Allows you to link different types of fiber optic cable to each other or to various equipment
- Allows you to mate interfaces of the same type or to create interconnection points in bulkheads
- Features bronze alignment sleeves and are compatible with single mode or multimode connectors



Fiber Optic Testers

200X 49886 FSP Fiber Optic Inspection

Scope



- 200X magnification to easily determine any contamination on ferrule end faces.
- Get rid of the most common cause of poor fiber transmission performance: dirt, dust, or scratches on end faces of fiber connectors.
- Eliminates the possibility of over-polishing.
- Features oblique viewing technology and will safely inspect your connectors with full laser eye protection through wavelengths of 85 to 1550 nanometers.

Black Box Pocket Fiber Tester & Pocket Opto Source



- Allows you to test multimode cables before or after they are installed
- Provides inexpensive fiber testing continuity on your multimode fiber optic cable, saves time on maintenance
- What makes this fiber tester unique is that it only generates 850-nm wavelength, so it looks like a red laser, it does not generate 1310 nm

Black Box Multimode Test Sets

- Allows you to pinpoint test results within 0.1-dB resolution
- Efficient battery usage, only requires a single 9-volt battery for power
- Constructed of machined aluminum to withstand wear and tear in tough environments



 **BLACK BOX**
NETWORK SERVICES

GREENLEE 560XL Fiber Optic Power Meter

- Measures optical power at 850, 1300, 1310 and 1550nm and insertion
- 3 button operation – all functions are controlled easily (continuous wave output mode, modulated output mode & selectable modulation frequency)
- Loss measurements in db relative units; power measurements in dBm



Greenlee 5890 FC, SC, or ST Multimode and Single Mode Fiber Optic Test Set w/FC, SC, or ST Interface

- Kit designed to measure length, integrity, and frequency of the fiber optica cabling
- 850/1300nm loss measurements
- 1310/1550nm loss measurements
- Created with technicians in mind to help them perform installation and maintenance measurements on fiber optic cabling networks



Black Box Singlemode & Multimode Test Kit

- Allows you to accurately measure power loss in passive optical components
- Large LCD display makes it easy to read
- Stores up to 999 readings per wavelength and can be uploaded to your PC



IDEAL 33-983 SIGNALTEK™-FO w/2 850nm Modules & 2 1310nm Modules

- Qualify both copper and fiber-optic per IEE 802.3 standards for use on every job.
- Comes with 850 and 1310 modules so that you can test 850nm and 1310nm wavelengths to support virtually all LAN and campus fiber applications
- Tester comes with internal memory as well as USB thumb drives so you can store and later print Qualification reports for copper and fiber jobs



Fluke CertiFiber® and SimpliFiber® Fiber Optic Testers

- Uses LED light sources at 850 nm and 1300 nm.
- Supplied with ST interchangeable connector adapters.
- Includes CertiFiber, CertiFiber Remote, LinkWare Software, Carrying Case, DM9M to DB9F Serial Cable, (6) AA Alkaline Batteries and User Guide



Fiber Optic Testers - Pulse Suppressor (Test Box)



Single Port Test Box

- Used to remove the “dead zone” from OTDR measurements.
- Used as calibration comparison for OTDR measurements.
- Used as a long haul system loop back for field testing transmission.
- Standard 1 km fiber lengths (custom lengths available).
- Three meter input and output fiber lengths (custom lengths available).
- Impact and crush resistant packaging.
- Can be terminated with any style connector.
- Single mode or multimode fiber available.
- Handle included for portability.
- Consists of light weight, hard plastic.

Kingfisher Fiber Optic Test Equipment



- The KI 3600 series Optical Power Meter from Kingfisher is used for testing system power and attenuation in fiber optic communications systems as well as helping to identifying fiber.



- The KI 3800 series Optical Light source is used for testing loss in optical fiber systems, at 1 to 2 wavelengths on singlemode and multimode fiber cable.

Advanced Single-mode Optical Loss Test Set



- Large, backlit LCD display makes it easy to view power levels and calibration wavelengths.
- Operation is simple due to the user-friendly keypad and intuitive controls.
- Remote operation permits the automation of tedious or repetitive measurements.
- 3 test voltages
- 3 measuring ranges



Cleaning Products

MGC-824 Isopropyl Alcohol



- All purpose cleaner is safe for use on plastic, pc boards, connectors, fiber optics, connectors and contacts, semi-conductors, tape heads, office and medical equipment, and relays

Mini Tub Lint-Free FiberCare Wipes



- Optical-grade lint free wipes
- Designed to work with solvents
- Stronger than cellulose wipes
- Perfect for "wet / dry" fiber optic connector cleaning
- Ideal for cleaning bare fiber
- Perfect size for cleaning fibers after stripping

FiberCare™ Fiber Connector Cleaner



- Only solvent designed to work as a system with FiberCare™ Cleaning Sticks
- Unlimited shelf life
- Fast drying optical-grade solvent
- Dissipates static charges from connector end faces
- Safe on fiber, connectors, glass, metal, cured epoxies
- Available in 3 oz (85g) pump dispenser or case of 12

FiberCare™ Hands-Free Fiber Preparation Fluid



- Non-hazardous optical-grade solvent
- Fast acting
- High purity
- Perfect for "wet / dry" connector end-face cleaning
- Safe on glass, metal, epoxies, and circuit boards
- Available in a 3 oz hands-free dispenser or a case of 12

Fiber Optic Consumable Kits & Fan Out Kits



LEVITON

- Leviton's Consumables Kits contain everything you need to clean and polish fiber optic connectors, such as polyester wipes, alcohol pads, music wire, and lapping film. Fiber Optic Fan Out Kits protect bare fiber and prepare loose tube cable for direct termination to industry standard connectors.

Connector Cleaning Sticks



- Cleans any connector on any configuration
- Ultra clean nibs to wick liquids and trap particulates
- Molded fibrous nib is cleaner and more absorbent
- Conforms to end-face geometry, including APC
- Plastic clam shell packaging fits easily into toolbox
- Oversized handle keeps nib clean until used
- Convenient and economical packaging
- Unlimited shelf life
- 12 month warranty



Termination Kits

Mini Fiber Termination Kit



- Carbide Scribe
- Syringes
- TFS-1400 Stripper
- A/B Fast Epoxy
- ST & SC Polishing Disc
- Wipe Papers
- TFS-1200 Fiber Scissors
- Fiber Optics CrimpTool
- 6um Diamond Polish Film
- 1um Diamond Polish Film

Black Box Fiber Optic Tool Kits



- Available in Standard and Deluxe models with an assortment of professional-grade tools you need to reliably and efficiently terminate your fiber optic cable
- The ergonomically designed tools included in the kits reduce hand strain caused by day-in, day-out termination tasks
- All the tools in these kits allow you to avoid the expense and wasted time that result from improperly terminating fiber cable

Fiber Optic Termination Kit



- This kit's durable Cordura® nylon case keeps tools organized and protected, and includes see-through pouches for easy connector storage
- Outside pockets are perfect for storing worksite documents and instruction manuals
- Case is equipped with strong handles, as well as eyelets for the addition of a shoulder strap

TKT-UNICAM Tool Kit

CORNING

- Basic kit for single fiber and 2-fiber UniCam Connectors
- Terminates ST, SC, LC, FC, and 2-Fiber MT-RJ connectors
- Includes all of the necessary tools: crimper, cleaver, strippers, scissors and more
- Keeps everything in the included Standard Tool Bag



TKT-UniCam® Pretium Tool Kit

- Save time and money with Corning's Pretium tool kit that lets you terminate a connector up to 30% faster than other Unicam Tool Kit
- The UniCam Pretium Tool Kit can terminate LC, SC and ST **multimode** and **single mode** UniCam connectors, eliminating the need for multiple termination kits
- The tool kit is organized to decrease the time you need to establish and clean up a job site
- Improves your success rate by giving you instant reliable go/no results with every termination

